

dyson

Owner's manual
Please read this guide carefully
before using your DC14.

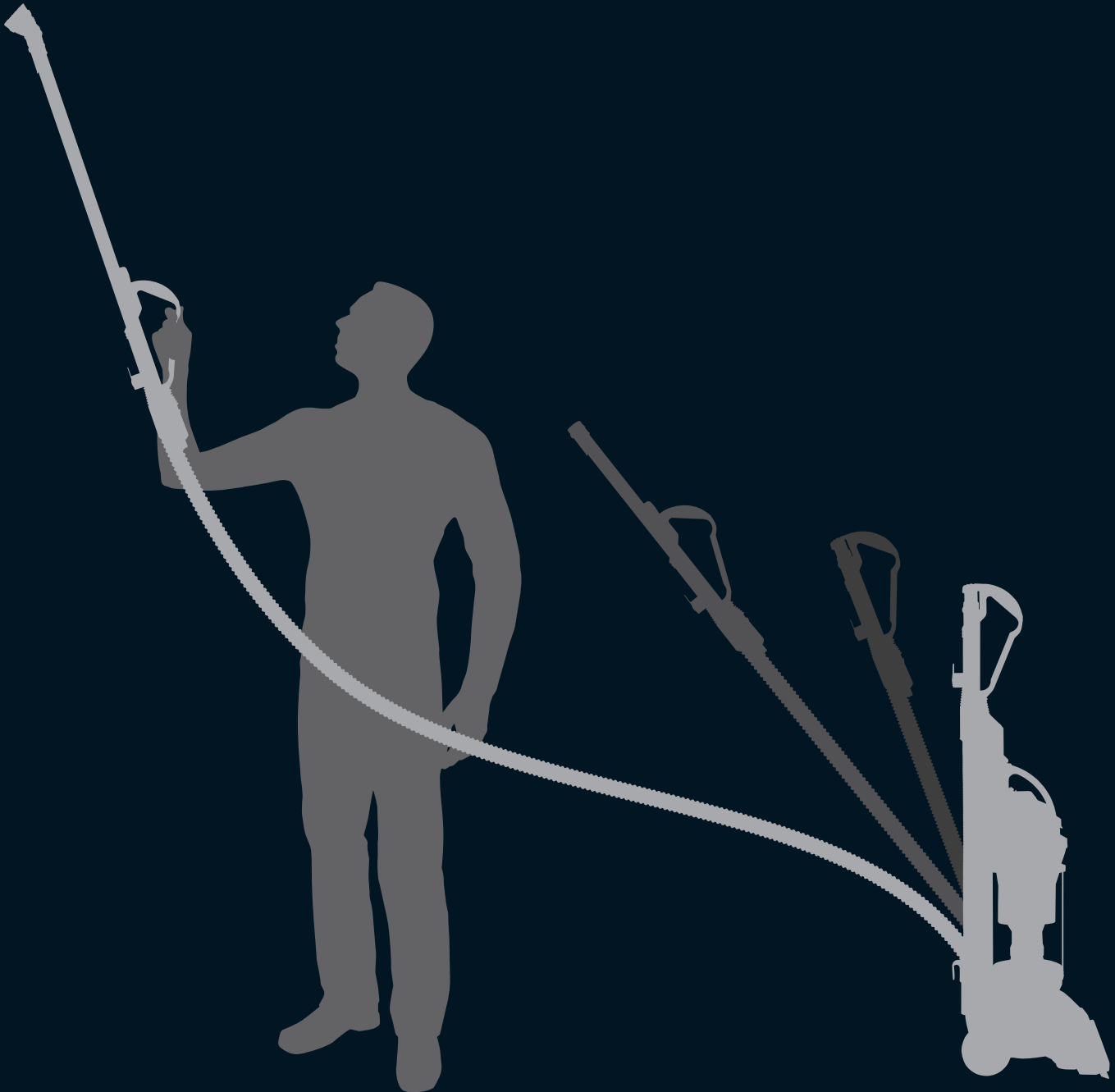

**DC
14**

IMPORTANT SAFETY INSTRUCTIONS

READ ALL INSTRUCTIONS BEFORE USING THIS VACUUM CLEANER

When using an electrical appliance, basic precautions should always be followed, including the following:

WARNING

TO REDUCE THE RISK OF FIRE, ELECTRIC SHOCK, OR INJURY:

- 1 Do not leave appliance when plugged in. Unplug from electrical outlet when not in use and before servicing.
- 2 Do not use outdoors or on wet surfaces or to vacuum water or other liquids – electric shock and personal injury could occur.
- 3 Do not allow to be used as a toy. Close attention is necessary when used by or near children.
- 4 Do not allow use by anyone unable to operate the vacuum properly.
- 5 Use only as described in this manual. Use only with Dyson-recommended attachments, accessories, and replacement parts.
- 6 Check to ensure your electricity supply to that shown on the rating plate, which can be found on the base of the machine between the wheels. The machine must only be used as rated.
- 7 If the machine is not functioning properly, has been dropped, damaged, left outdoors, or immersed in liquid, contact the Dyson Helpline at 1-866-693-9766.
- 8 Do not use with a damaged cord or plug. Do not pull or carry by the cord; do not use the cord as a handle; do not close a door on the cord or pull the cord around sharp edges or corners. Do not run the machine over the cord. Keep the cord away from heated surfaces and open flames.
- 9 Do not unplug by pulling on the cord. To unplug, grasp the plug, not the cord.
- 10 Do not handle the plug or machine with wet hands.
- 11 Do not use the machine without the Clear bin™ and the filters in place.
- 12 Do not put any objects into openings in the machine. Do not use with any opening blocked; keep free of dust, lint, hair, and anything that may reduce air flow.
- 13 Keep hair, loose clothing, fingers, and all parts of body away from openings in the machine and moving parts, such as the brushbar.
- 14 Do not use the machine to pick up sharp hard objects, small toys, pins, paper clips, etc., because they may damage the machine.
- 15 The use of an extension cord is not recommended.
- 16 Store the machine indoors. Put the machine away after use with the cord wrapped safely to prevent tripping accidents.
- 17 Turn off all controls before unplugging.
- 18 Take extra care when cleaning on stairs; always work with the machine at the bottom of the stairs. Keep vacuum on the floor. Do not put the machine on chairs, tables, etc.
- 19 Do not pick up anything that is burning or smoking, such as cigarettes, matches, or hot ashes.
- 20 Do not use to pick up flammable or combustible liquids, such as gasoline, or use in areas where they may be present.
- 21 When vacuuming, certain carpets may generate small static charges in the Clear bin or wand. These are not associated with the electricity supply. To minimize any effect from this, do not put your hand or insert any object into the Clear bin unless you have first emptied it and rinsed it out with cold water.
- 22 Do not carry out any maintenance or repair work other than that shown in this manual or advised by the Dyson Helpline.
- 23 Consult your flooring manufacturer's recommended instructions before vacuuming and caring for your flooring, rugs, and carpets. Some carpets will fuzz if a rotating brushbar is used when vacuuming. If this happens, we recommend vacuuming in bare floors mode and consulting with your flooring manufacturer.

SAVE THESE INSTRUCTIONS

THIS APPLIANCE IS INTENDED FOR HOUSEHOLD USE ONLY

Polarization instructions

To reduce the risk of electric shock, this appliance has a polarized plug (one blade is wider than the other). This plug will fit in a polarized outlet only one way. If the plug does not fit fully in the outlet, reverse the plug. If it still does not fit, contact a qualified electrician to install the proper outlet. Do not change the plug in any way.

Owner's manual

Please read this guide carefully before using your DC14.

Important safety instructions	Page 2
Box contents	4
Assembling	5
Using your DC14	6
Washing your filter	7
Using your DC14 tools	8
Emptying the Clear bin™	9
Cleaning the Clear bin™	10
Clearing blockages	11
Brushbar maintenance	12
Optional accessory use and maintenance	13
Troubleshooting tips	15
Limited warranty and customer care	16

Box contents

CAUTION

• Please see the back of the manual for usage and maintenance instructions for accessories included with some vacuums.

• If you have any questions, please call the Dyson Helpline at 1-866-693-9766 or log on to www.dyson.com

Additional accessories may be included with some models.

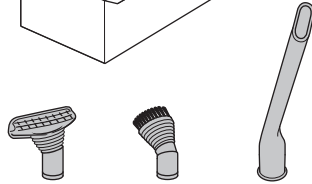
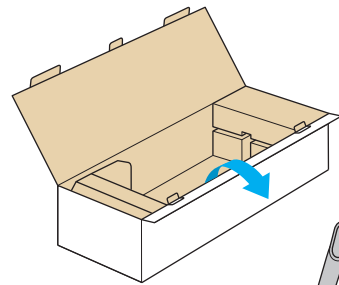

Stair tool Brush tool Crevice tool

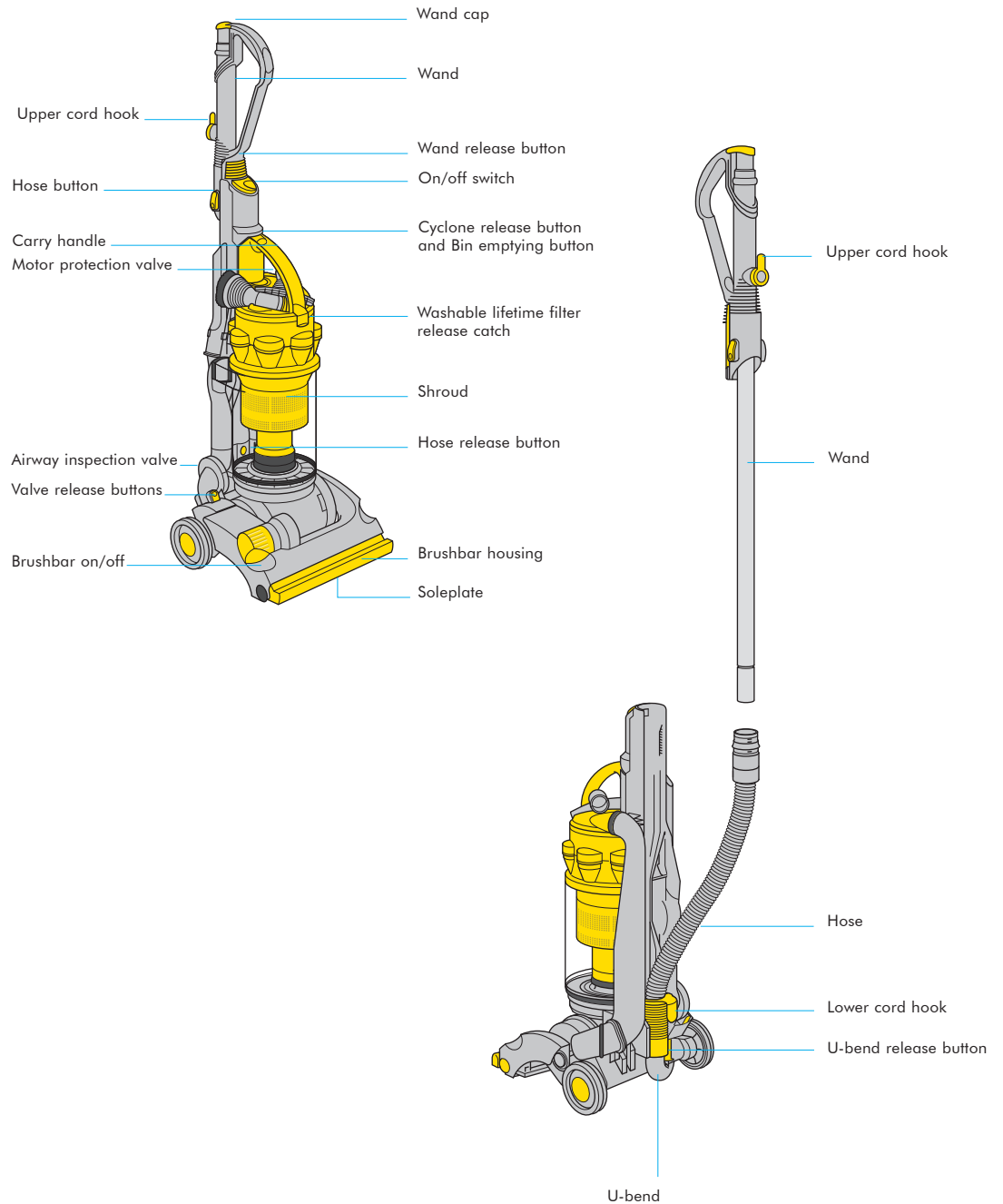
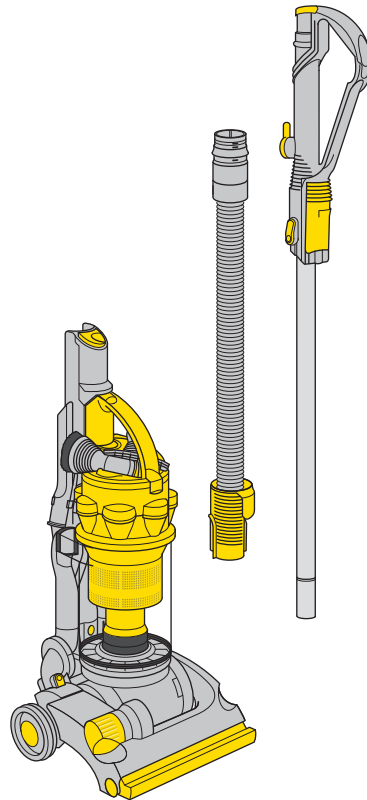

Assembling

⚠ CAUTION

- Ensure the wand cap cover is closed.
- Ensure hose is straight when inserting wand into hose.

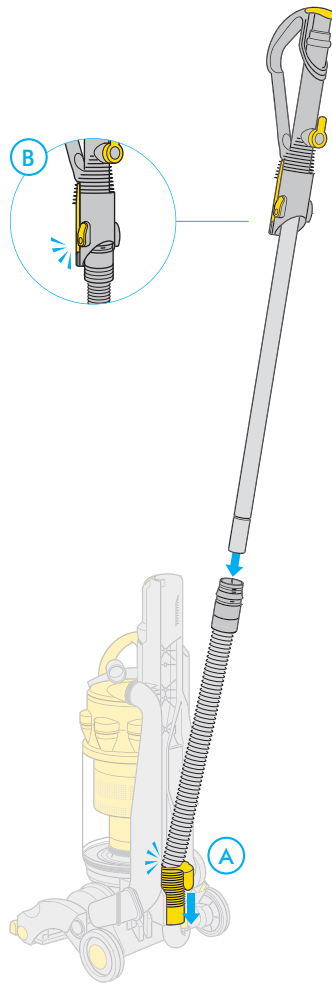

A Slide hose into guides at back of machine and click into place.

B Slide wand straight down in to hose until it clicks into place. Ensure hose does not bend.

Click wand handle into top of machine.

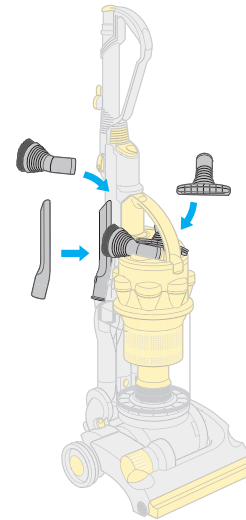

Click tools into place.

Wind cord counter-clockwise around cord hooks and secure with clip.

tip To quickly release cord, rotate upper cord hook downward. Rotate cord hook back up before re-winding cord.

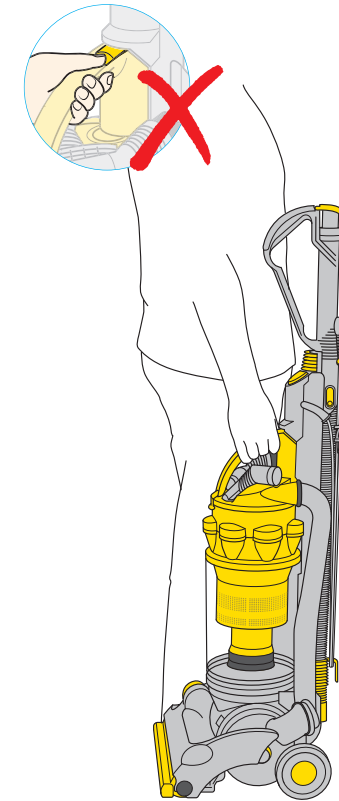
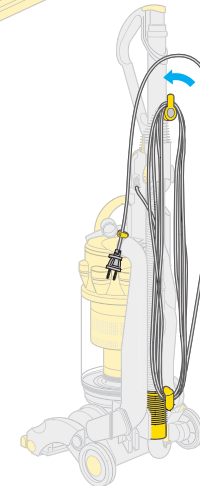

Use the carry handle to lift the machine.

Using your DC14

⚠ WARNING

- The machine is intended for domestic use only.
- Fine dust such as plaster dust or flour should only be vacuumed in very small amounts.

⚠ CAUTION

- **Do not** press the cyclone release button while carrying the machine, or it could fall and cause injury.
- Ensure the cyclone pack is secured to the machine.
- **Do not** shake the machine while carrying, or it could fall and cause injury.
- Keep hair and loose fabrics away from wand cap when machine is on.
- Use machine in bare floors mode for bare or delicate flooring, rugs, and carpets.
- Ensure the machine is in an upright position before adjusting the setting.

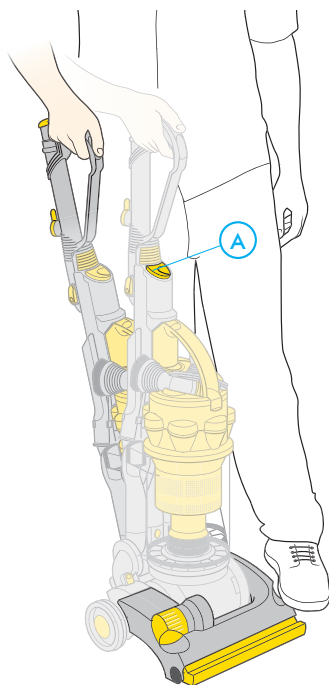
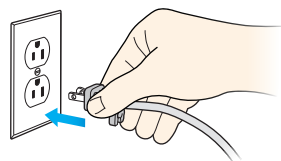

After plugging machine into electric outlet, press on/off button **A**, push cleaner head down with foot and pull handle towards you.

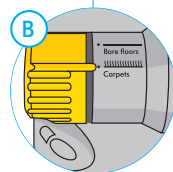
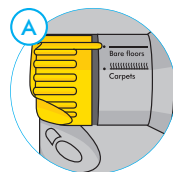
**Brush control system**

A Bare floors: Use this setting to stop brushbar from turning when vacuuming bare or delicate flooring, rugs, and carpets.

B Carpets: Use this setting so brushbar turns when vacuuming non-delicate surfaces.

tip The brushbar will not turn until you tilt the handle backwards to begin vacuuming.

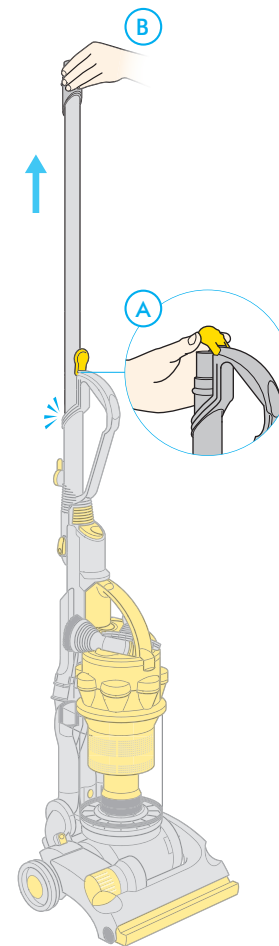
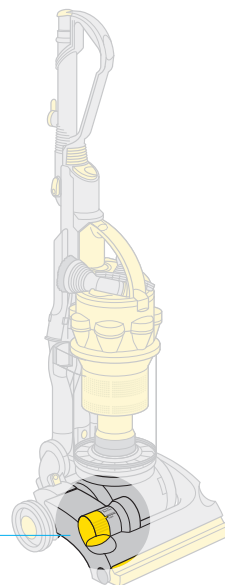
**Tools**

A Push back wand cap.

B Pull wand from inside wand handle until it clicks into place.

Consult your flooring manufacturer's recommended instructions before vacuuming and caring for your flooring, rugs, and carpets. Some carpets will fuzz if a rotating brushbar is used when vacuuming. If this happens, we recommend vacuuming in bare floors mode and consulting with your flooring manufacturer.

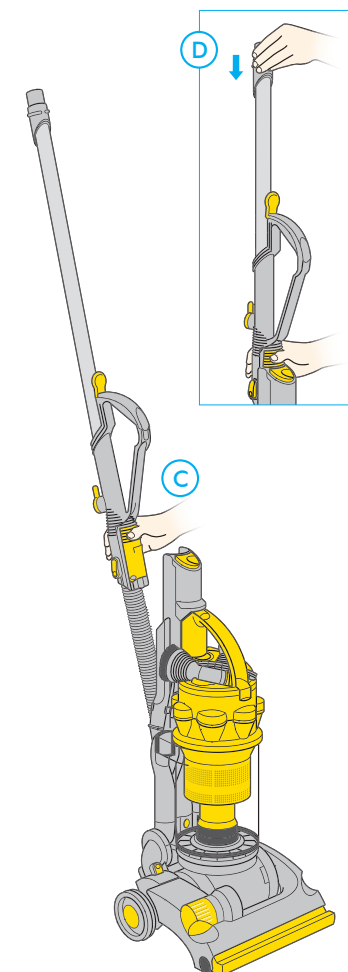

C Press button to release hose and wand handle from machine.

D To push wand back inside hose, ensure hose is straight. Press the same wand release button and push wand back inside wand handle.

Washing your filter

⚠ CAUTION

• Check your washable filter regularly and wash at least every 6 months according to instructions to maintain performance.

• Turn power off and unplug before washing the filter. Failure to do so

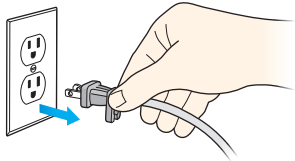

could result in electric shock or personal injury.

• **Do not** use detergent to clean filter.

• **Do not** put the filter in the dishwasher, washing machine, clothes dryer, microwave, or near an open flame.

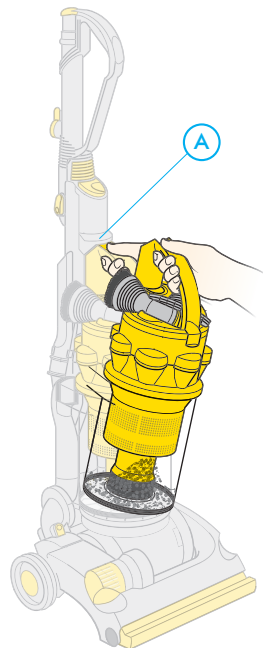

Press cyclone release button **A** to release cyclone pack.

- The filter may require more frequent washing based on individual vacuuming habits. Check regularly.

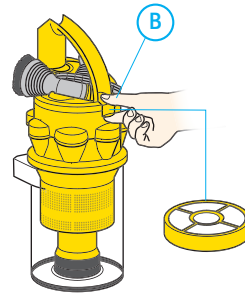

Accessing the filter

Lift washable lifetime filter release catch **B** and remove filter.



Washing the filter

- Wash filter and case in cold water only.
- Only wash blue foam and yellow case.
- Wash filter and case until water runs clear.

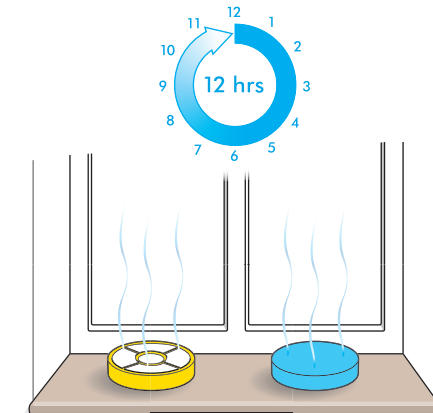

Air dry for at least 12 hours.

Ensure filter and case are completely dry before refitting onto the machine.

Using your DC14 tools

⚠ CAUTION

- Powerful suction can cause the hose to 'pull back' in use – please take care when using the hose.
- To avoid personal injury and to prevent the machine from falling when cleaning stairs, always place it at the bottom of the stairs.
- Do not use your vacuum cleaner outdoors or on wet surfaces. Vacuum may be used inside a garage only when used with the Model 08909 Dyson Car Cleaning Kit accessories. If used in a garage, care should be taken to wipe the soleplate and wheels with a dry cloth after vacuuming to clean off any sand, dirt, or pebbles that could damage delicate floors.

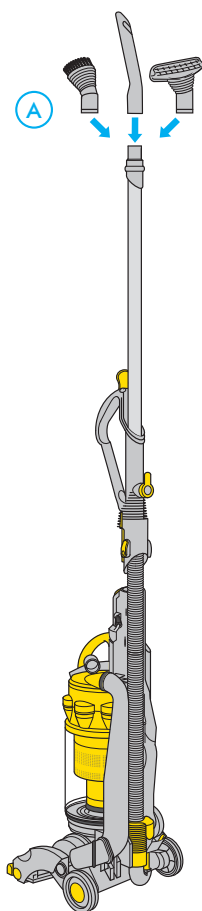

A Tools can be fitted directly to the end of the wand for cleaning hard to reach places.

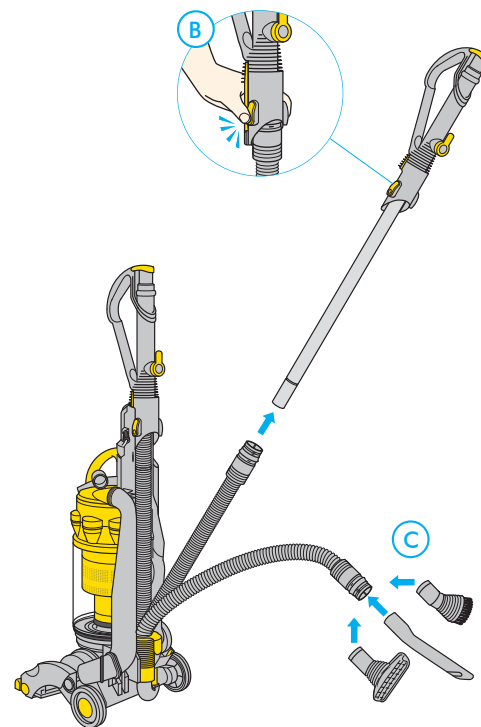

B To fit tools directly to hose, first extend the wand. Then press hose release buttons to remove wand handle from the hose.

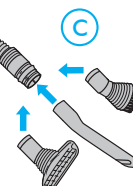

C The tools can also be fitted directly to the end of the hose.
For your safety, when the hose is fully extended, grasp firmly by the hose, not the tool.

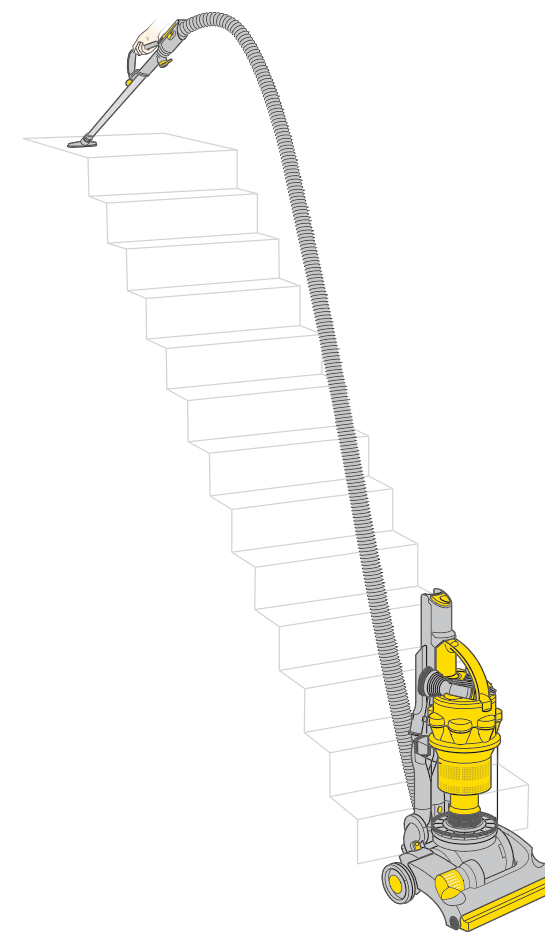

Always work with the machine at the bottom of the stairs.

Emptying the Clear bin™

⚠ CAUTION

- Turn power off and unplug before emptying the bin. Failure to do so could result in electric shock or personal injury.

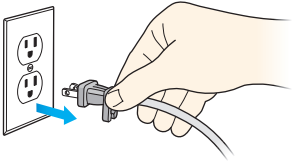

- Do not use the machine without the Clear bin in place.



The British Allergy Foundation is a UK national charity with the aim of improving awareness, prevention, and treatment of allergies.

The British Allergy Foundation Seal of Approval is a UK registered trademark.

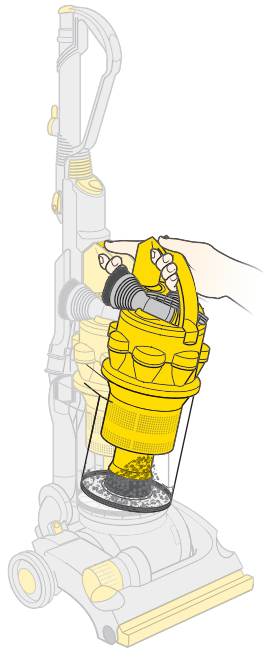

Empty the Clear bin as soon as the **MAX** mark is reached. Press cyclone release button to release cyclone from machine.

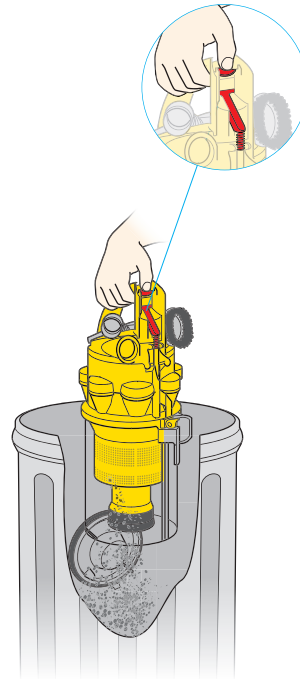

Option A
Push the red bin emptying button as shown to release the bin base and empty directly into trash.

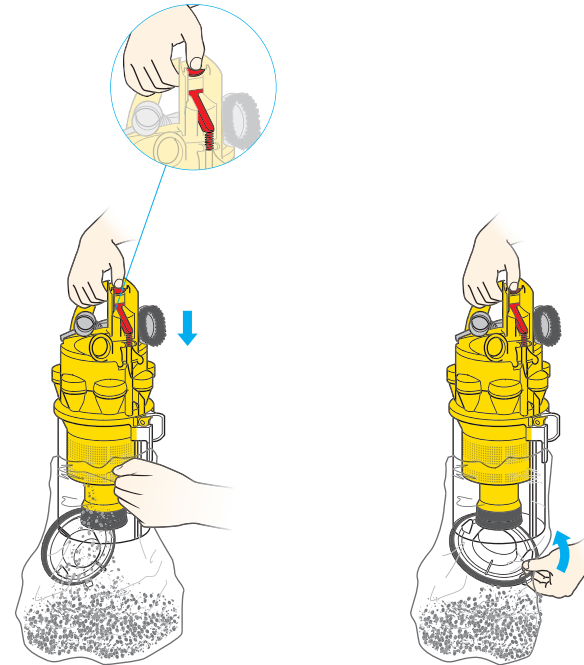

Option B
Emptying into a bag is recommended for allergy sufferers. Place bin in bag and push red bin emptying button.



Let the dust settle and close bin base securely before removing from bag and refitting cyclone and bin on machine.

Cleaning the Clear bin™

⚠ CAUTION

- **Do not** use detergents, polishes, or air fresheners to clean the Clear bin.
- **Do not** immerse the cyclone in water.
- Ensure the bin is completely dry before refitting.

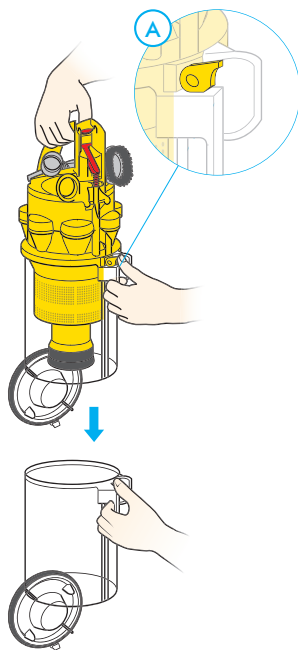
**Cleaning the shroud***(if necessary)*

Ensure the bin has been emptied and bin base is open.

Press catch **A** to release Clear bin.

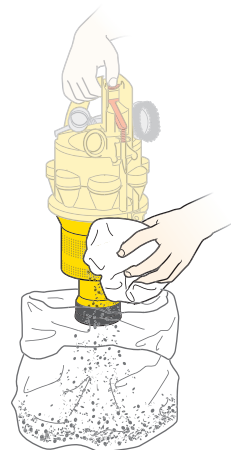

Clean shroud with a cloth or small brush to remove lint.

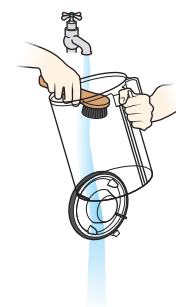
**Cleaning the Clear bin™**

Clean Clear bin with a cloth or small brush.

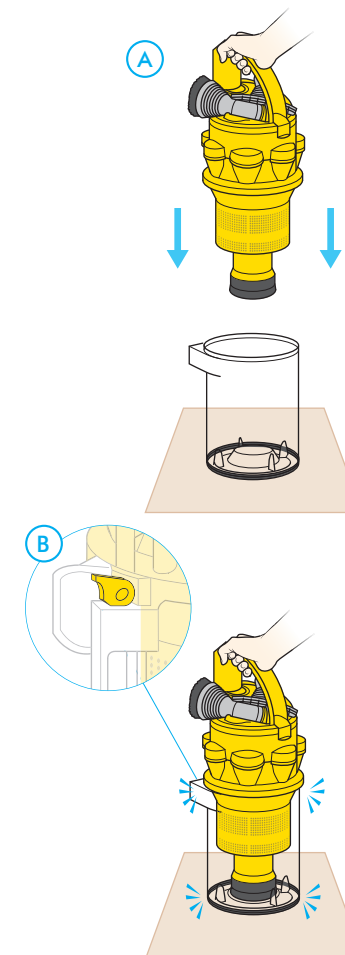
**Reassembling the Clear bin™**

A Hold the carry handle and place the cyclone into the Clear bin.

B Line up the front and rear guides and push down to click into place. Ensure the Clear bin is secure before replacing on the machine.

Clearing blockages

⚠ CAUTION

- Turn power off and unplug before checking for blockages. Failure to do so could result in electric shock or personal injury.

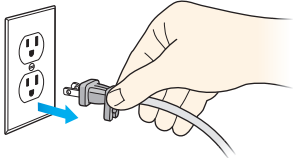

- If any part of your machine becomes blocked, it may overheat and then automatically shut off. Unplug machine and leave to cool down for at least 60 minutes.
- Please note: Clearing blockages is not covered by your machine's limited warranty.
- Beware of sharp objects when clearing blockages.
- Refit all parts of the machine before using it.
- If you hear a loud 'ratcheting' noise it means the brushbar is obstructed.
- The 'ratcheting' noise may also occur if your carpet or area rug is not adequately attached to the floor. If this happens, you should vacuum in bare floors mode.

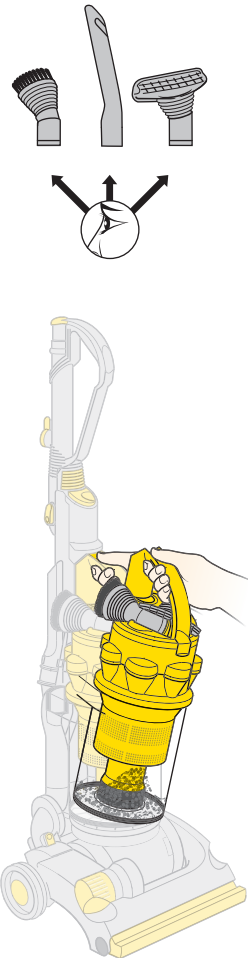

Check tools are clear of blockages.

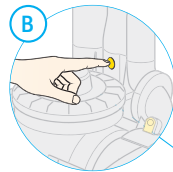

Wand and hose

- A** Remove wand by pressing hose release buttons and sliding hose off wand. Check inside wand and hose for blockages.
- B** Press lower hose release button at front of machine and slide hose out from the rear, holding lower cord hook.

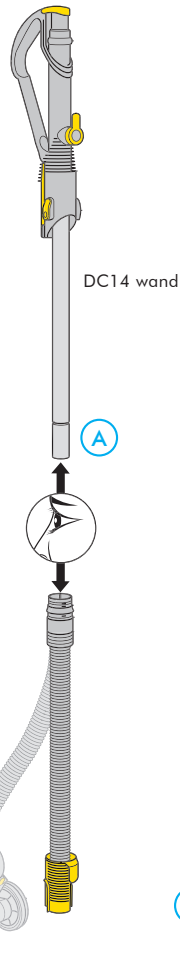

U-bend inspection

- C** Tilt machine forward, slide out U-bend, and check inside for blockages.

Airway inspection

- D** Squeeze valve release buttons and check inside for blockages.

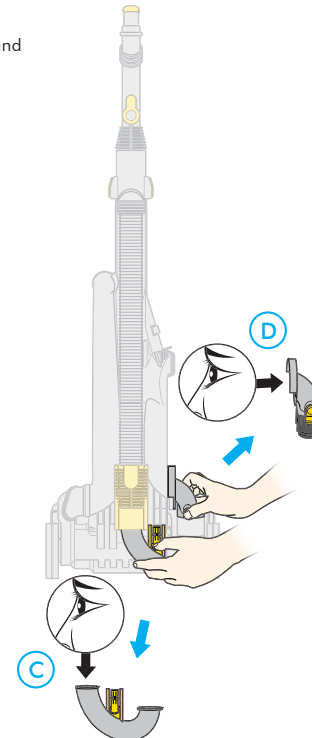

Brushbar maintenance

CAUTION

- Turn power off, unplug machine, and allow machine to cool for 60 minutes before brushbar maintenance. Failure to do so could result in electric shock or personal injury.

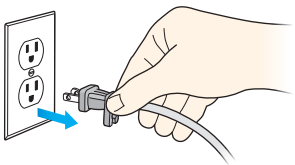

- Ensure soleplate is in correct position before use.
- Make sure all parts have been replaced securely before using your machine.

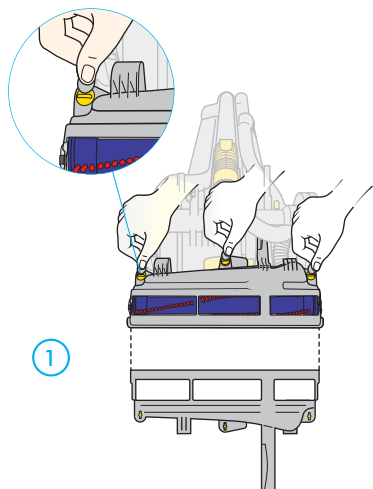

1

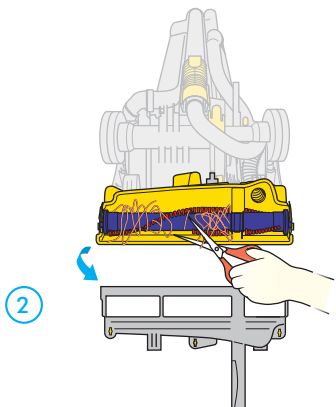

2

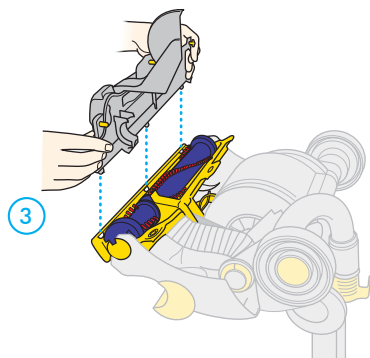

3

Lay the vacuum on its front.

- 1 Undo soleplate fasteners using a coin and remove soleplate.
- 2 Remove lint and hair from brushbar.

- 3 Rest the three tabs on inside of bumper strip and secure soleplate back into position.

When replacing the soleplate, it must be fitted securely with the bottom of the cleaner head to achieve optimal performance. Check the alignment of the soleplate with the front edge of the cleaner head.

Optional accessory use and maintenance

⚠ CAUTION

Do not use your vacuum cleaner outdoors or on wet surfaces. Vacuum may be used inside a garage only when used with the Model 08909 Dyson Car Cleaning Kit accessories. If used in a garage, care should be taken to wipe the soleplate and wheels with a dry cloth after vacuuming to clean off any sand, dirt, or pebbles that could damage delicate floors.

Colors may vary.



Low reach floor tool

For easier cleaning under low furniture

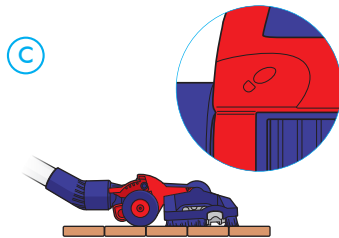
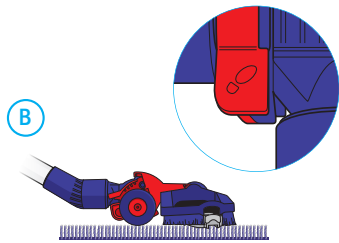
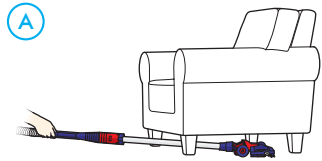

- A** Attach low reach floor tool to wand and recline handle
- B** Carpet – Press rear pedal
- C** Bare floors – Press front pedal



Mini turbine head

Advanced turbine head removes dirt from upholstery, stairs, and the car

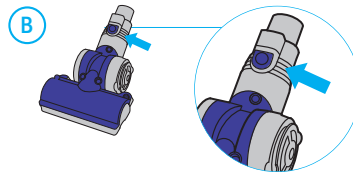
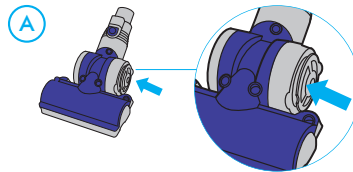
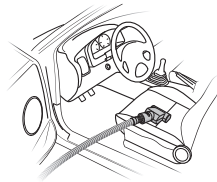

- A** Push in to stop brushbar from spinning
- B** Adapter release button not used on all models

Mini turbine head maintenance

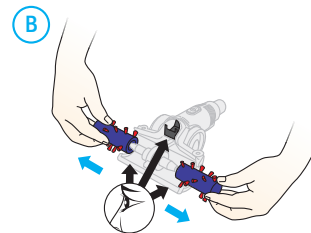
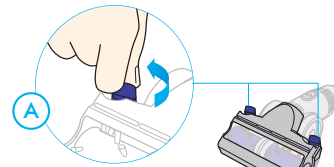

- A** Remove soleplate
- B** Remove and clean brushbars

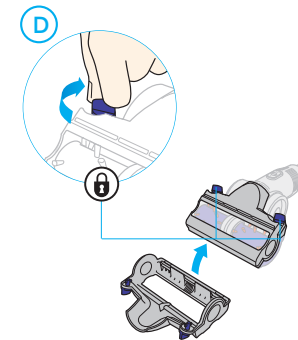
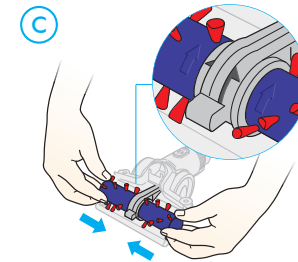

- C** Replace brushbars
- D** Replace soleplate

Optional accessory use and maintenance

Optional accessory
use and maintenance



Flexi crevice tool

Extends and flexes to clean awkward gaps and spaces

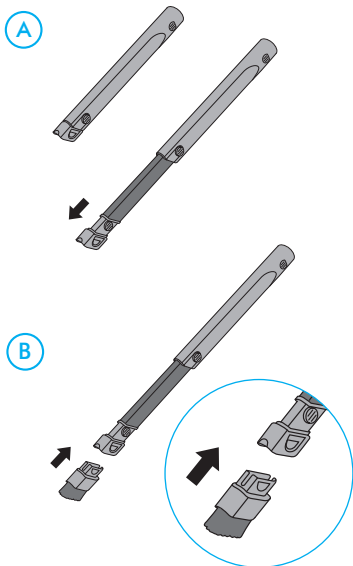
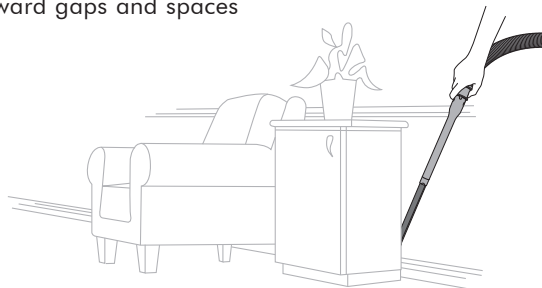

- A** Extend and flex
- B** Use with or without brush



Zorb carpet powder

Use Zorb for carpet cleaning

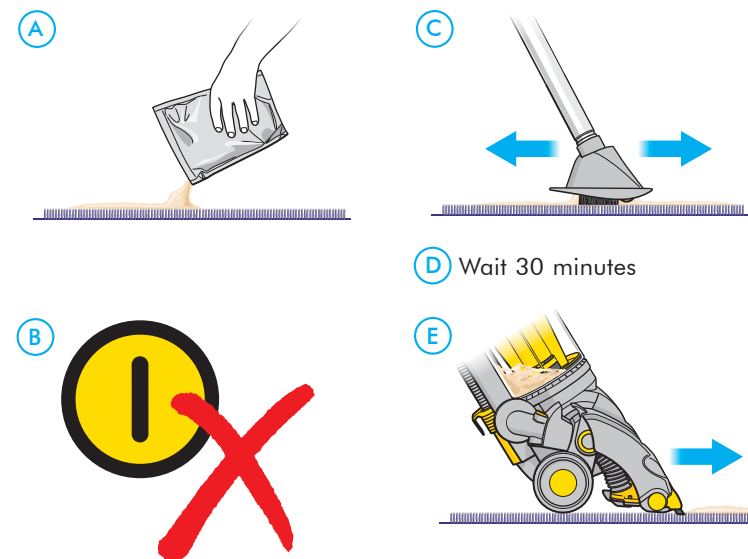
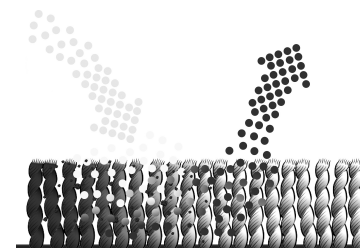

- A** Sprinkle Zorb onto carpet
- B** Ensure machine is turned off
- C** Work into carpet pile
- D** Wait 30 minutes
- E** Vacuum the carpet

Troubleshooting your Dyson

Refer to page 4 for an illustration of your DC14.

If this does not help with your problem, please call the Dyson Helpline at **1-866-693-9766**.

The Helpline is open 7 days a week to answer your questions.

Problem	Potential solution
Less than normal or no pickup from cleaner head or Machine turns off in use	<ul style="list-style-type: none"> • If vacuuming non-delicate carpeting, ensure brush control is set on carpets mode. Note: brushbar will only spin when the handle is reclined. • Remove and check washable filter to see if it is clean (filter should be blue in color). Wash filter if necessary as shown on page 7. • If you removed the soleplate, it must be refitted flush with the cleaner head. If it is not, refit soleplate as shown on page 12 and re-check performance. • Be sure the filter housing, U-bend, and airway inspection valve are snapped in securely and confirm there are no blockages.
Less than normal or no suction from wand or hose	<ul style="list-style-type: none"> • Confirm the U-bend is in place and that there are no blockages. • Remove the wand and check for blockages. • Confirm the hose has no blockages or holes by stretching it out. • Be sure the filter housing and airway inspection valve are snapped in securely and confirm there are no blockages. • Remove and check washable filter to see if it is clean (filter should be blue in color). Wash filter if necessary as shown on page 7.
Brushbar not spinning	<ul style="list-style-type: none"> • Ensure brush control is set on carpets mode. Note: brushbar will only spin when the handle is reclined.
Loud 'ratcheting' noise coming from cleaner head when vacuuming	<ul style="list-style-type: none"> • Ratcheting may indicate there is an obstruction in the brushbar and is meant to protect the belt in the machine. Note: the ratcheting may also occur if your carpet is not adequately attached to the floor or if your rug has loose tassels. (This noise does not hurt the machine.) • Check to see if there is an obstruction in the brushbar as shown on page 12. • Note: when refitting the soleplate it must be fitted securely. Affix as shown on page 12. If there is no obstruction, you may want to set brush control to bare floors mode.
Unit will not stand upright	<ul style="list-style-type: none"> • Stand behind the vacuum holding the handle at a 45 degree angle. • Locate and remove the airway inspection valve and take note of the square plastic molding where the airway inspection valve plugs into. (It should slide up and down.) • Snap that square plastic piece up toward the ceiling. • After it snaps into place, the unit will stand upright.

Dyson customer care Thank you for choosing to buy a Dyson.

If you have a question about your Dyson vacuum cleaner, call the Dyson Helpline at **1-866-693-9766** with your serial number and details of where and when you bought the cleaner. Your serial number can be found on the rating plate, which is on the base of your machine between the wheels. Most questions can be solved over the phone by one of our Helpline staff. If your machine needs service, call the Dyson Helpline. We will discuss with you the options available for service. If your machine is under warranty and it is a covered repair, your machine will be repaired at no cost. To reach the Dyson Helpline call at **1-866-693-9766** toll free, or visit Dyson online at www.dyson.com

Limited 5 year household warranty

To help us ensure you receive prompt and efficient service, please register your purchase with us. There are two ways to do this:

- by completing and returning the enclosed form to us by mail.
- online at www.dyson.com

This will confirm ownership of your Dyson in the event of an insurance loss and enable us to contact you if necessary. If you have any questions about your Dyson, please call our Helpline at 1-866-693-9766, 7 days a week, or log on to our website at www.dyson.com

Terms and Conditions of the Dyson 5 year limited warranty



Your serial number can be found on the rating plate, which is on the base of your machine between the wheels.

Note your serial number for future reference:

□□□□□□□□□□□□□□

What is covered

Your Dyson vacuum cleaner is warranted against original defects in material and workmanship for a period of five years from the date of purchase, when used for private household purposes in accordance with the Dyson Owner's Manual. This warranty provides, at no extra cost to you, all labor and parts necessary to ensure your vacuum cleaner is in proper operating condition during the warranty period. This warranty is subject to the following terms:

What is not covered

Dyson, Inc. shall not be liable for costs incurred as a result of:

- Machines purchased from an unauthorized dealer.
- Clearing blockages from your machine.
- Use of parts not in accordance with the Owner's Manual.
- Careless operation or handling, misuse, and/or lack of maintenance or use not in accordance with the Owner's Manual.
- External sources such as weather.
- Repairs or alterations carried out by unauthorized parties or agents.
- Use of the vacuum cleaner other than for normal domestic household purposes within the United States, e.g., for commercial or rental purposes.
- Use of parts and accessories other than those produced or recommended by Dyson, Inc.

Warranty Service

- Please fill out and return the Product Registration Form, or register on line at www.dyson.com
- Before service can take place, the terms of the warranty require that you contact the Dyson Helpline with your model name/number, serial number, and date and place of purchase. Please keep your purchase receipt in a safe place to ensure you have this information. The serial number is found on the vacuum cleaner's rating plate, which is on the base of your machine between the wheels.
- All work will be carried out by Dyson, Inc. or its authorized agents.
- Any replaced defective parts will become the property of Dyson, Inc.
- Service under this warranty will not extend the period of this warranty.
- If your machine is not functioning properly, please call the Dyson Helpline at 1-866-693-9766. Most issues can be rectified over the telephone by our trained customer care staff. If this is not possible Dyson, Inc. will arrange for your vacuum cleaner to be repaired and returned in full working order at no extra cost to yourself.

Terms and Conditions (continued)**Warranty Limitations and Exclusions**

- Any implied warranties relating to your vacuum cleaner, including but not limited to warranty of merchantability or warranty of fitness for a particular purpose, are limited to the duration of this warranty. This limitation is not allowed by some states and so this limitation may not apply to you.
- Your remedy for breach of this warranty is limited to the warranty service described above. Dyson, Inc. will not be liable for any consequential damages or incidental damages you may incur in connection with your purchase and use of your vacuum cleaner. This limitation is not allowed by some states and so this limitation may not apply to you.
- This warranty gives you specific legal rights. You may also have other rights which vary by state.
- This warranty is not transferable.

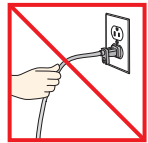

Do not pull on the cord.



Do not place on stairs above you.

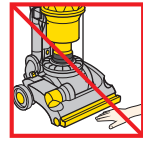

Do not put your hands near the brushbar when in use.



Do not use near open flame.

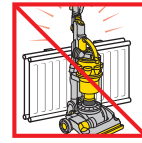

Do not leave vacuum near heat sources.

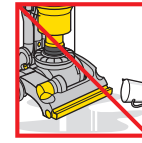

Do not pick up water or liquids.

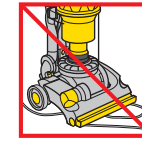

Do not run over the cord.

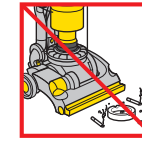

Do not pick up burning objects.

This product is protected by the following intellectual property rights:

Patent/Patent Application numbers: US 2004/0128789, JP 2004-537336, EP1361812, GB2393383, AU 2003269161, CA 2,497,762, EP1542574, JP 2004-539183, US 10/528,804, WO2004/028329, AU 2003269349, EP 1542576, JP 2004-539173, AU744408, EP1119282, JP 2002-527132, US6,519,807, AU2002231965, EP1361813, JP2002-567126, US 2004-0068829, AU744362, EP1121043, JP 2002-527131, US6,572,078, AU757043, EP1052923, JP 2001-525208, US6,691,849, GB0326102.1, AU2002226556, EP1370172, JP 2004-528876, US2004-0074213, AU2002225207, EP1361814, JP 2004-520137, AU2001240894, EP1268076, GB2360719, JP2003-528704, US 6,835,222, AU2002225232, EP1361815, GB2372435, JP 2004-520139, US2004-068827, GB2372436, AU637 272, EP0636338, JP 1948 863, US5,078,761

Registered Design/Application numbers: AU154578, EP 000090865-0001 GB3012888, JP 1213916, US29/193,623, GB3015739

Please note: Small details may vary from those shown.

www.dyson.com